

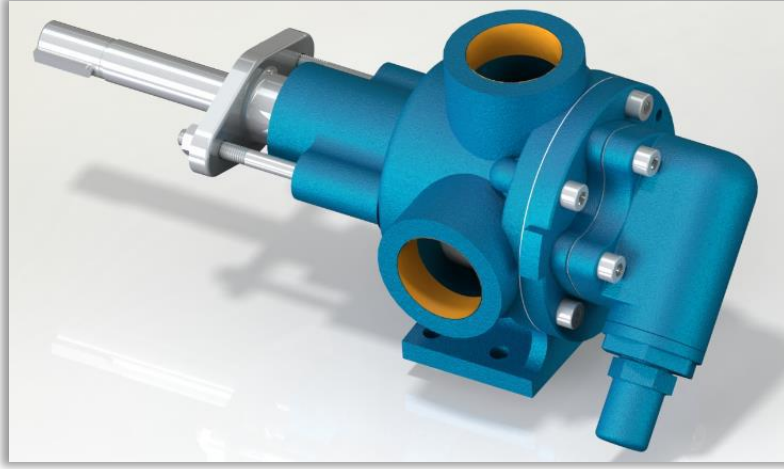

YP 1½ " POMPA INTERNAL ECCENTRIC GEAR PUMP



POMPA DEĞERLERİ / PUMP PROPERTIES

Q	: 5,5 m ³ /h
Hm	:1 ~ 7 Bar
T	:0 ~ 100 °C
n	:1400 d/d
Visc.	:100 ~ 75.000 SSU

KULLANIM ALANLARI

- Fuel Oil Servis Tankları, Gaz Yağı, Mazot Tankerlerinde
- Reçine,
- Kağıt ve Boya Sanayinde,
- Küçük çapta kızgın yağ sirkülasyonlarında
- İlaç, kimya ve deterjan sanayinde,
- Gıda Sanayinde.

USE AREAS

- Fuel Oil Service Tanks, Gasoil, Diesel Tankers
- Resin,
- Paper and Paint/dye industry
- Circulation of Hot Oil (limited)
- Medicine, Chemical and Detergent Industry
- Food Industry.

MALZEME SEÇENEKLERİ

- Pompa Gövdesi, Kapaklar : Dökme (pik) demir, çelik döküm, paslanmaz AISI 304 / 316 döküm
- Dişliler : Dökme (pik) demir, çelik döküm, paslanmaz AISI 304 / 316 döküm, sfero döküm
- Yataklar : Snbz 12 bronz, karbon grafit, Silisyum Karbür, Sert Metal Kaplama
- Sızdırmazlık: Keçeli Sistem

MATERIAL OPTIONS

- Pump Body, covers : Cast iron, steel cast, stainless AISI 304 / 316 cast.
- Gears : Cast iron, steel cast, stainless AISI 304 / 316 cast, Spheroidal cast iron.
- Bearings: Snbz 12 bronze, carbon graphite, silicon carbide, hard metal coated steel.
- Sealing: Lip seal



YP 1½ " POMPA INTERNAL ECCENTRIC GEAR PUMP



İÇTEN EKSANTİK DİŞLİ POMPA ÇALIŞMA PRENSİBİ / WORKING PRINCIPLE OF INTERNAL ECCENTRIC GEAR PUMP

Yıldız Pompa' nın "dişli içinde dişli" prensibinde sadece iki tane hareketli parça vardır. Bütün pozitif deplasmanlı YILDIZ dişli pompalarının güvenilir ve verimli çalışmasının sırrı budur. Sıvının pozitif deplasmanı (yer değiştirmesi) rotor ve avare dişlisinin dişleri arasındaki boşluğun komple dolmasıyla sağlanmaktadır. Bütün dişli pompalarda olduğu gibi, YILDIZ POMPA' da da performansın en üst noktaya çıkmasını sınırlayıcı yegane faktör, pompalanan sıvının diğerlerine göre daha temiz olmasını istemesidir.

Pompa milinin her devrinde emiş ağızı yoluyla belli bir miktar sıvı pompaya girer. Bu sıvı rotor ile avare dişlisi arasındaki boşluğu doldurur. Pompa kapağında bulunan hilal, çıkış ağızına doğru pürüzsüz şekilde hareket eden sıvının akışını ayırır. Kendi dişleri ile hilalin iç yüzeyi arasında sıvı taşıyan avare dişlisi pompa kapağının desteklediği bir mil üzerinde döner. Dişleri arasında sıvı taşıyan rotor dişlisi pompa gövdesi ile hilalin dış yüzeyi arasında hareket eder ve pompa miline bağlıdır.

YILDIZ's simple "gear-within a gear" principle has only two moving parts. It is the secret of dependable, efficient operation of all positive displacement YILDIZ POMPA's PUMPS. The positive displacement of liquid is accomplished by the complete filling of the spaces between the teeth of the rotor and idler gears. The only limiting factor to peak performance in YILDIZ POMPA, as with all rotary pumps, is that the liquid pumped must be comparatively clean.

With every revolution of the pump's shaft, a definite amount of liquid enters the pump through the suction port. This liquid fills the spaces between the teeth of the rotor and the idler. The crescent on the pump head splits the flow of liquid as it moves smoothly towards the discharge port. The idler gear, which carries the liquid between its teeth and the inside surface of the crescent is connected to pump cover. On the otherhand, rotor gear which is rotated directly with pump shaft delivers the liquid between gear teeth and crescent's souter surface.

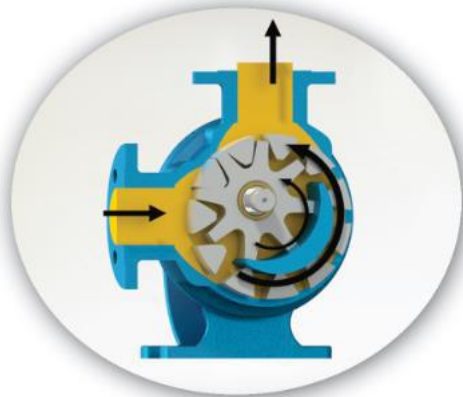
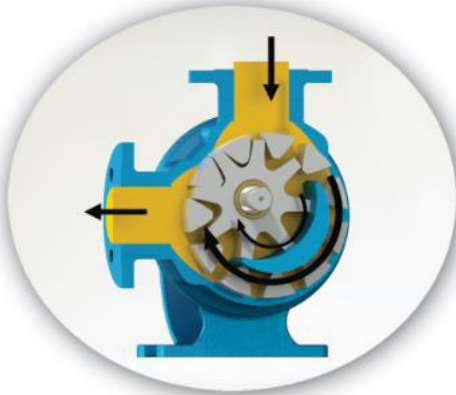

YP 1½ " POMPA INTERNAL ECCENTRIC GEAR PUMP



Yandaki renkli kısım sıvının pompa gövdesindeki emiş ağızı alanına, rotor dişlisi ve avare dişlisi dişleri arasındaki dişli boşlukları alanına girişini gösterir. İki siyah ok pompanın dönüş ve sıvının ilerleyişini gösterir.

The yellow colored portion at side indicates the liquid as it enters the suction port area of the casing and the area between the rotor teeth and corresponding concave area between the idler teeth. The two black arrows indicate the pump rotation and progress of the liquid.



"Dişli içinde dişli" prensibinde çalışan dişliler ile pompa içinde sıvının ilerleyişine dikkat edin. Aynı zamanda, pompa kapağı üzerindeki hilal şeklinin sıvıyı nasıl böldüğüne ve emiş ile boşaltma ağızları arasında bir keçe (conta) gibi vazife gördüğüne dikkat ediniz.

Notice the progress of the liquid through the pump and between the teeth of rotor idler gear. Also, note how the crescent shape on the head divides the liquid and acts as a seal between the suction and discharge ports.



Bu resim pompanın iç kısmının dolup sıvının boşaltma ağızı alanına itilmesinden hemen önceki durumunu göstermektedir. Avare ve rotor dişlilerinin dizaynının sıvı için nasıl bir kapalı cep oluşturduğuna ve bunun tam bir hacim kontrolü sağlanmasını nasıl garantilediğine dikkat ediniz.

This illustration shows the pump in a nearly flooded condition just previous to the liquid being forced into the discharge port area. Notice how the gear design of the idler and rotor form locked pockets for the liquid to guarantee absolute volume control.



Bu görüntü pompanın tamamen dolup taşıdığı durumu ve sıvının boşaltma işlemini, boşaltma ağızından ilerleyişini göstermektedir. Emiş ve boşaltma ağızlarına eşit mesafede sızdırmaz bir keçe oluşturan, sıvıyı boşaltma ağızından dışarı doğru iten, rotor ve avare dişlisinin dişleri birbiri içine geçer.

The view shows the pump in a completely flooded condition and in the process of discharging the liquid through discharge port. The rotor and idler teeth mesh, forming a seal equidistant between the both ports, forcing liquid out the discharge port.



**YP 1½ " POMPA
INTERNAL ECCENTRIC
GEAR PUMP**



YP-1½" POMPASINA AİT KAPASİTE VE GÜÇ TABLOSU / CAPACITY AND POWER TABLE					
KAPASİTE (m³/h) CAPACITY (Q)	DEVİR (d/d) SPEED (rpm)	ÇIKIŞ BASINCI / PRESSURE			VİSKOZİTE VISCOSITY
		2 Bar	5 Bar	7 Bar	
3,5	900	1,5 HP	1,5 HP	2 HP	750 SSU
5,5	1400	1,5 HP	2 HP	3 HP	100 SSU

MOTOR GÜÇLERİ MOTOR POWERS		MOTOR GÜÇLERİ MOTOR POWERS	
1,5 HP	900 d/d (rpm)	1,5 HP	750 d/d (rpm)
1,5 HP	1400 d/d (rpm)	2 HP	900 d/d (rpm)
2 HP	1400 d/d (rpm)	3 HP	1400 d/d (rpm)

MOTOR GÖVDESİ MOTOR BODY	MOTOR GÖVDESİ MOTOR BODY
90	100

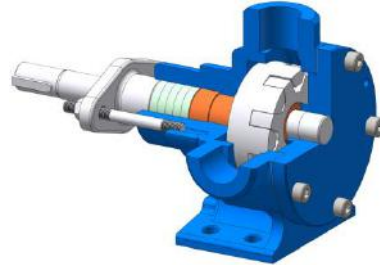
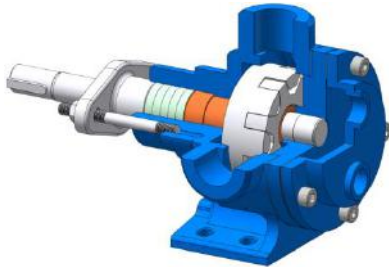
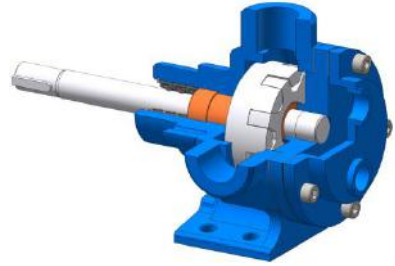
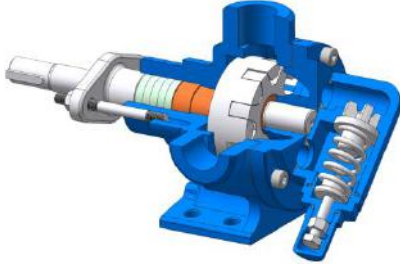



KAPASİTE EĞRİLERİ / CAPACITY GRAPHS

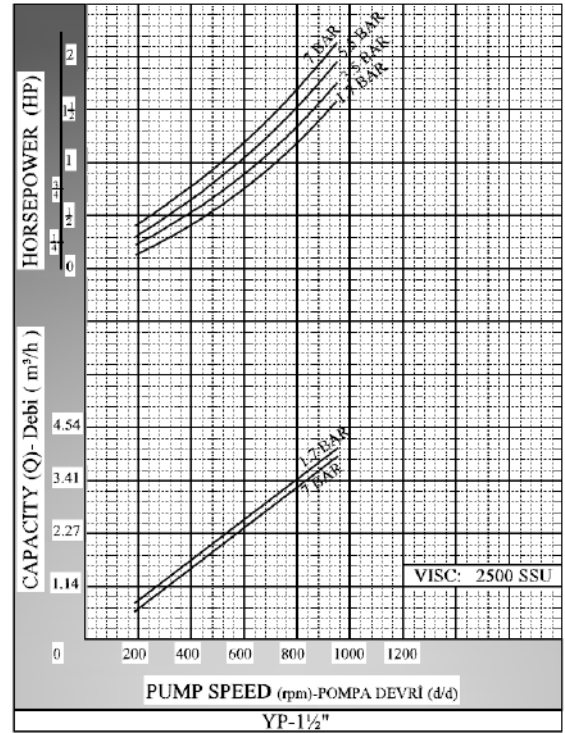
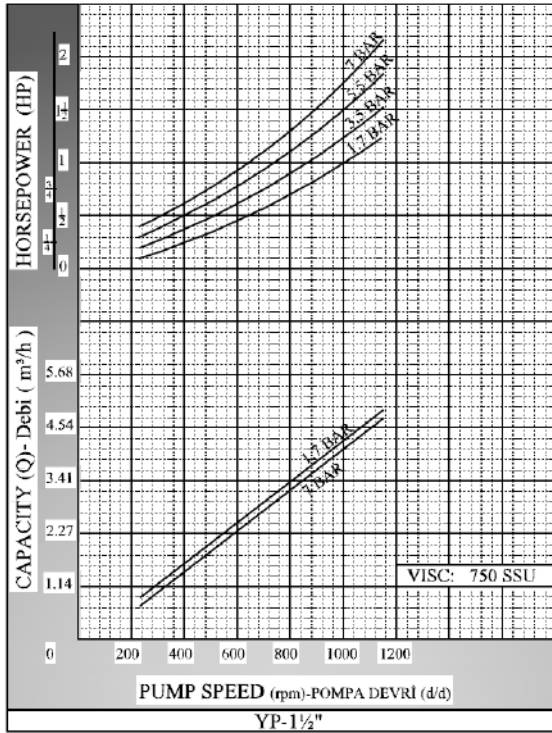
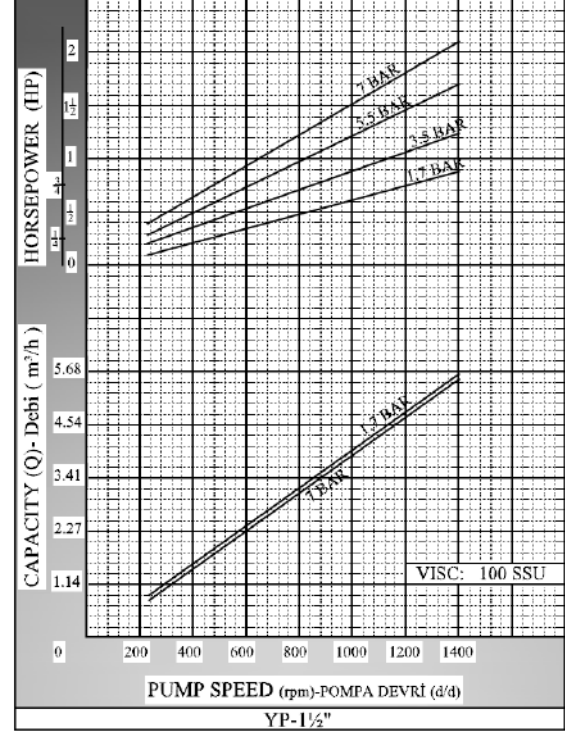
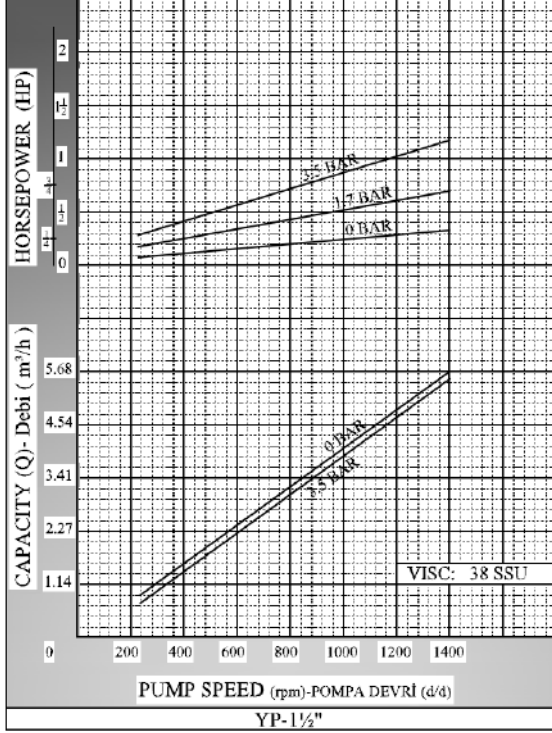



**YILDIZ
POMPA**

ilpomp

**YP 1½ " POMPA
INTERNAL ECCENTRIC
GEAR PUMP**

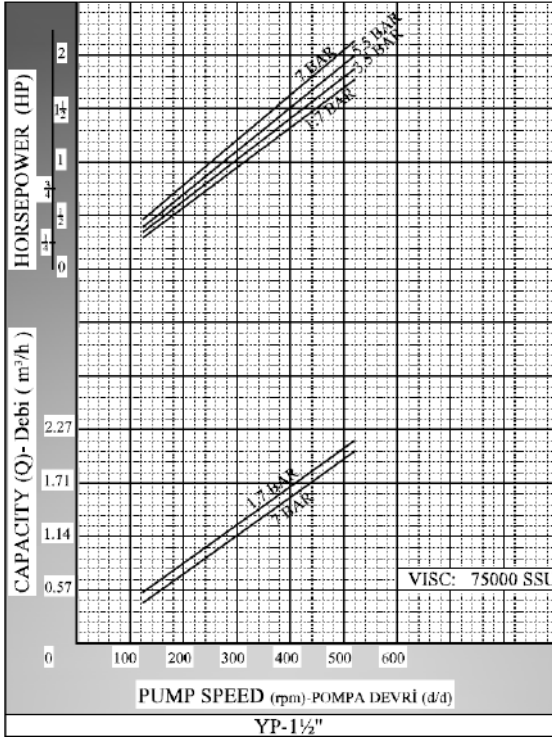
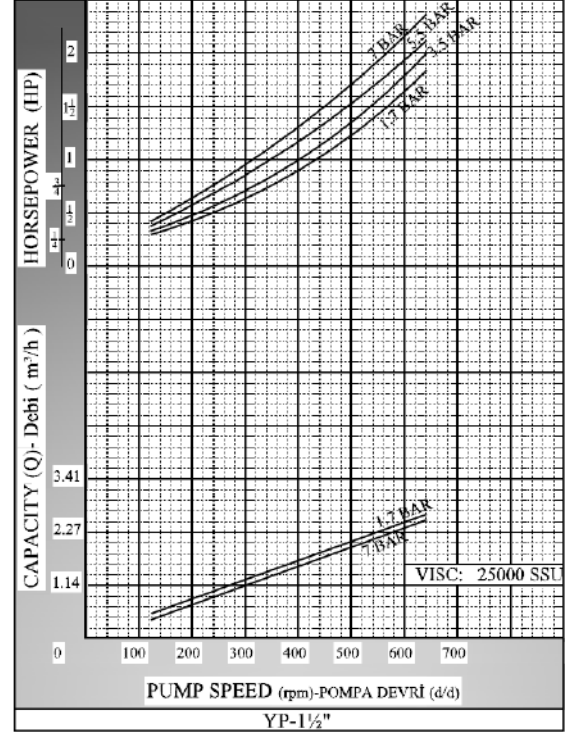
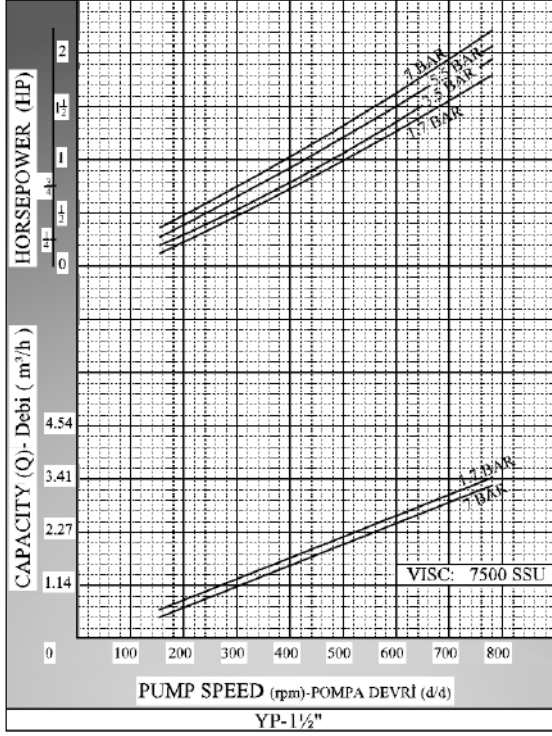

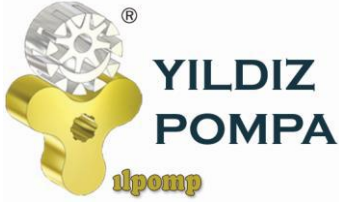

YP 1½ " POMPA INTERNAL ECCENTRIC GEAR PUMP



POMPA BOYUT ÖLÇÜLERİ / PUMP DIMENSIONS

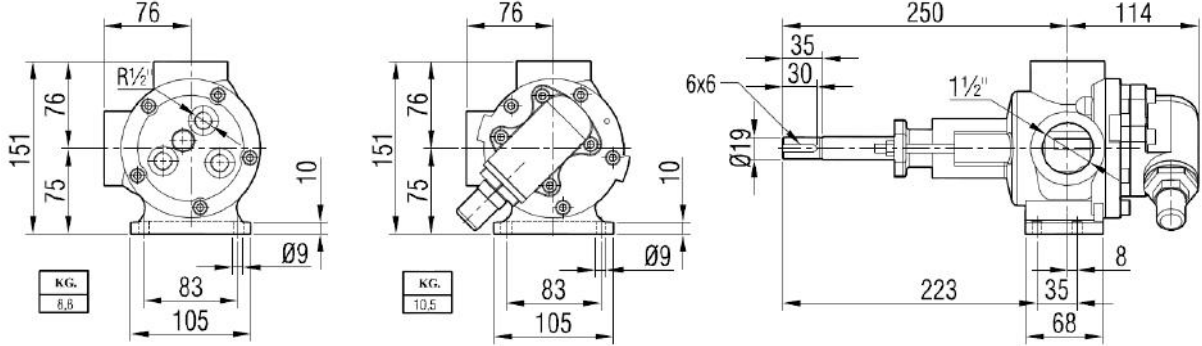

AKUPLAJ ÖLÇÜLERİ / COUPLING DIMENSIONS

MOTOR VE REDÜKTÖR AKUPELİ / MOTOR AND GEARBOX DRIVE

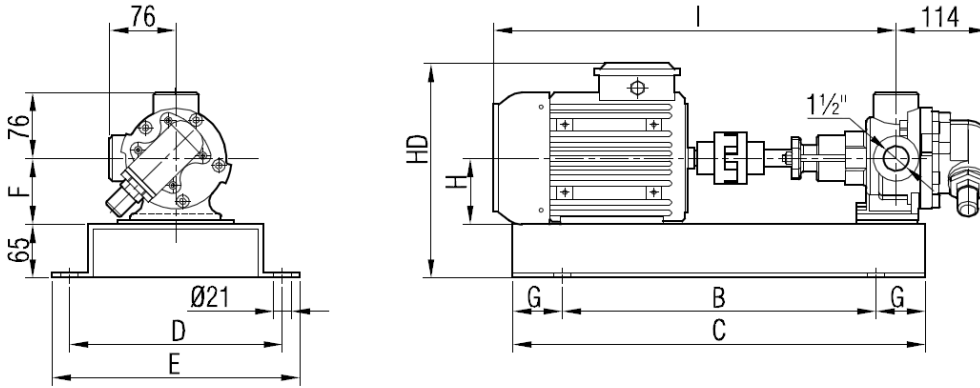

MOTOR GÜÇ VE DEVİRLERİ / MOTOR POWER AND SPEED			I	HD	H	B	C	D	E	F	G	kg.
1 hp / 0,75 kw	900 d/d (rpm)	MOTOR 90S	578	281	90	430	550	260	300	90	60	34
1,5 hp / 1,1 kw	1400 d/d (rpm)											
1,5 hp / 1,1 kw	900 d/d (rpm)	MOTOR 90L	603	300	100	420	620	310	350	100	100	48/52
2 hp / 1,5 kw	1400 d/d (rpm)											
1,5 hp / 1,1 kw	750 d/d (rpm)	MOTOR 100L	645	300	100	420	620	310	350	100	100	50
2 hp / 1,5 kw	900 d/d (rpm)											
3 - 4 hp / 2,2 - 3 kw	1400 d/d (rpm)	MOTOR112M	665	322	112	420	620	310	350	112	100	56
2 hp / 1,5 kw	750 d/d (rpm)											
3 hp / 2,2 kw	900 d/d (rpm)											
5,5 hp / 4 kw	1400 d/d (rpm)											57

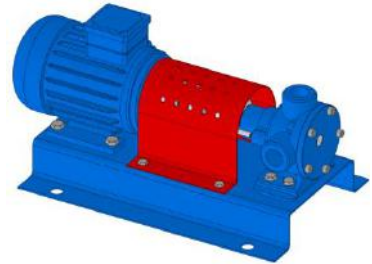
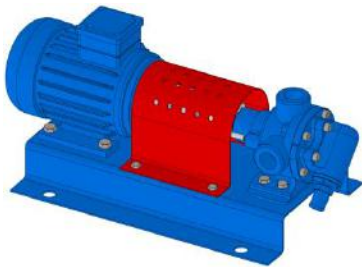

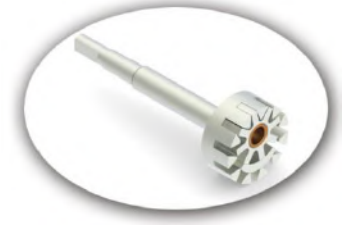

YEDEK PARÇA LİSTESİ / SPARE PARTS LIST

**YUMUŞAK SALMASTRALI VE BYPASSLI / SEALED WITH SOFT SEAL, AND PRESSURE RELIEF
VALVE ON COVER**

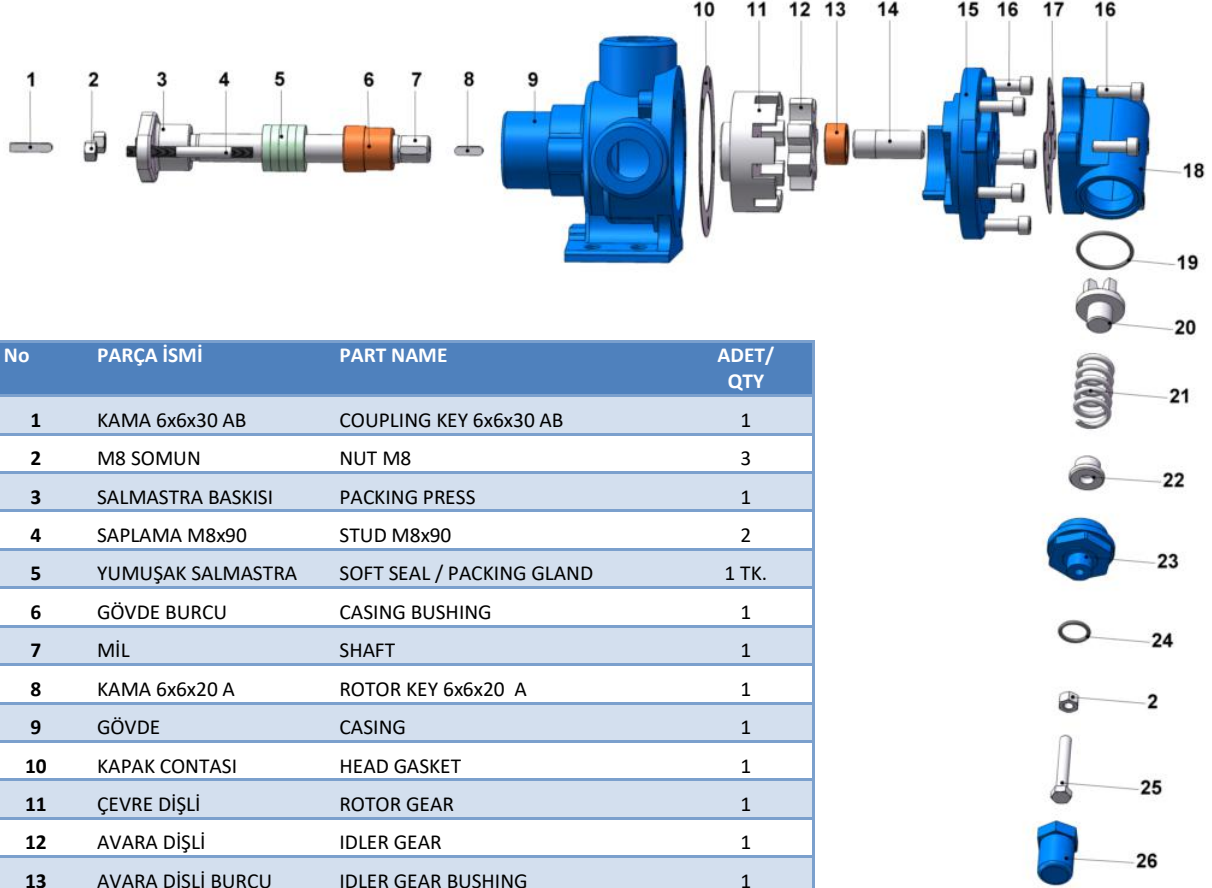

No	PARÇA İSMİ	PART NAME	ADET/ QTY
1	KAMA 6x6x30 AB	COUPLING KEY 6x6x30 AB	1
2	M8 SOMUN	NUT M8	3
3	SALMASTRA BASKISI	PACKING PRESS	1
4	SAPLAMA M8x90	STUD M8x90	2
5	YUMUŞAK SALMASTRA	SOFT SEAL / PACKING GLAND	1 TK.
6	GÖVDE BURCU	CASING BUSHING	1
7	MİL	SHAFT	1
8	KAMA 6x6x20 A	ROTOR KEY 6x6x20 A	1
9	GÖVDE	CASING	1
10	KAPAK CONTASI	HEAD GASKET	1
11	ÇEVRE DİŞLİ	ROTOR GEAR	1
12	AVARA DİŞLİ	IDLER GEAR	1
13	AVARA DİŞLİ BURCU	IDLER GEAR BUSHING	1
14	KAPAK MİLİ	COVER PIN	1
15	KAPAK (BYPASSLI)	COVER (w/ BYPASS INLETS)	1
16	IMBUS CİVATA M8x25	INBUS BOLT M8x25 FOR COVER	9
17	BYPASS CONTASI	BYPASS GASKET	1
18	BYPASS	PRESSURE RELIEF VALVE – BYPASS	1
19	BYPASS O-RING	BYPASS O-RING	1
20	KLEPE	VALVE	1
21	YAY	SPRING	1
22	PUL	WASHER	1
23	BYPASS KAPAĞI	BYPASS COVER	1
24	TİJ KAPAK O-RİNG	CAP O-RING	1
25	6 KÖŞE CİVATA M8x55	ADJUSTING SCREW M8x55	1
26	TİJ KAPAĞI	CAP	1



YP 1½ " POMPA INTERNAL ECCENTRIC GEAR PUMP



YEDEK PARÇA LİSTESİ / SPARE PARTS LIST YUMUŞAK SALMASTRALI, CEKETLİ VE KÖR KAPAKLI / SEALED WITH SOFT SEAL, JACKETED, AND WITH BLIND COVER

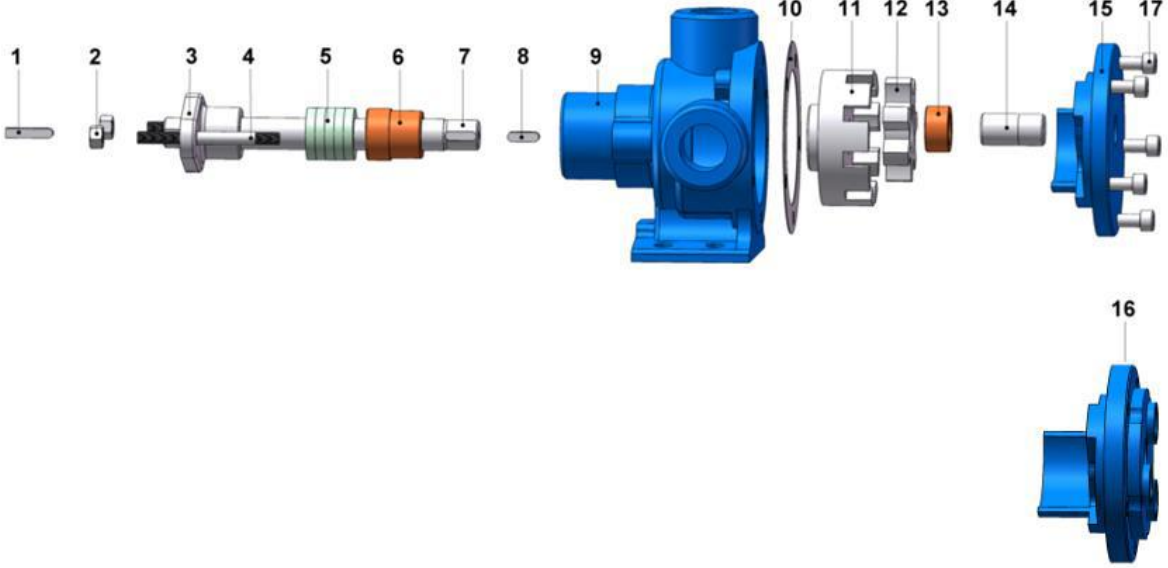

No	PARÇA İSMİ	PART NAME	ADET/ QTY
1	KAMA 6x6x30 AB	COUPLING KEY 6x6x30 AB	1
2	M8 SOMUN	NUT M8	2
3	SALMASTRA BASKISI	PACKING PRESS	1
4	SAPLAMA M8x90	STUD M8x90	2
5	YUMUŞAK SALMASTRA	SOFT SEAL / PACKING GLAND	1 TK.
6	GÖVDE BURCU	CASING BUSHING	1
7	MİL	SHAFT	1
8	KAMA 6x6x20 A	ROTOR KEY 6x6x20 A	1
9	GÖVDE	CASING	1
10	KAPAK CONTASI	COVER GASKET	2
11	ÇEVRE DİŞLİ	ROTOR GEAR	1
12	AVARA DİŞLİ	IDLER GEAR	1
13	AVARA DİŞLİ BURCU	IDLER GEAR BUSHING	1
14	KAPAK MİLİ	COVER PIN	1
15	KAPAK (KÖR)	BLIND COVER	1
16	KAPAK (CEKETLİ)	COVER (w/ HEATING JACKET)	1
17	IMBUS CİVATA M8x25	IMBUS BOLT M8x25 FOR BLIND COVER	5
	IMBUS CİVATA M8x30	IMBUS BOLT M8x30 FOR COVER (w/ HEATING JACKET)	5



YP 1½ " POMPA INTERNAL ECCENTRIC GEAR PUMP



YEDEK PARÇA LİSTESİ / SPARE PARTS LIST

KEÇELİ, CEKETLİ VE KÖR KAPAKLI / SEALED WITH LIP SEAL, JACKETED, AND WITH BLIND COVER

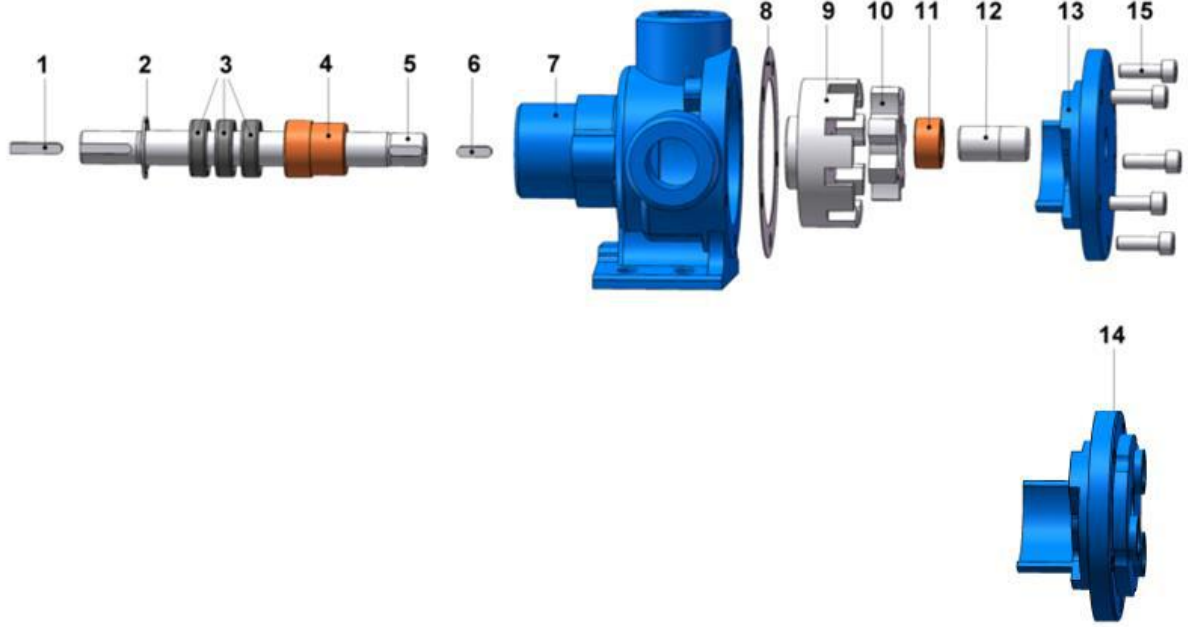

No	PARÇA İSMİ	PART NAME	ADET/ QTY
1	KAMA 6x6x30 AB	COUPLING KEY 6x6x30 AB	1
2	İÇ SEGMAN (ø33)	INTERNAL CIRCLIP (ø33)	1
3	KEÇE ø20xø33x10	LIP SEAL ø20xø33x10	3
4	GÖVDE BURCU	CASING BUSHING	1
5	MİL	SHAFT	1
6	KAMA 6x6x20 A	ROTOR KEY 6x6x20 A	1
7	GÖVDE	CASING	1
8	KAPAK CONTASI	COVER GASKET	2
9	ÇEVRE DİŞLİ	ROTOR GEAR	1
10	AVARA DİŞLİ	IDLER GEAR	1
11	AVARA DİŞLİ BURCU	IDLER GEAR BUSHING	1
12	KAPAK MİLİ	COVER PIN	1
13	KAPAK (KÖR)	BLIND COVER	1
14	KAPAK (CEKETLİ)	COVER (w/ HEATING JACKET)	1
15	IMBUS CİVATA M8x25	IMBUS BOLT M8x25 FOR BLIND COVER	5
	IMBUS CİVATA M8x30	IMBUS BOLT M8x30 FOR COVER	5
	CEKETLİ KAPAK İÇİN	(w/ HEATING JACKET)	