



WQ

Submersible sewage pump

50Hz



Nanfang Pump Industry Co.,Ltd.

CNP Headquarter

Address: Renhe Town, Hangzhou, China

Post code: 311107

Tel: +86 571 86051667,86390516,86390517

Fax:+86 571 86051696

E-mail: info@nanfang-pump.com

<http://www.cnppump.com>

E150322
subject to amendments



Company Profile



Founded in 1991, Nanfang Pump Industry Co., Ltd. (hereinafter referred to as CNP) has been listed on the Shenzhen Stock Exchange on 9th December 2010; Stock name: CNP; Stock code: 300145.

As the first enterprise specializing in the research and large-scale production of stainless steel stamping welded centrifugal pump in China, CNP is currently the professional manufacturer with the highest volume of production and marketing in that industry. It ranks first in the country in terms of product scope, sales volume, and production quality. The company has set up a complete network of marketing services to meet the requirements of overseas markets as well as domestic needs. The products have seen a wide range of application in the area of pressurization, industry, living water, cycling of air-conditioning water, heat supply, fire extinguishing system, pumping of underground water, treatment of sewage and waste water, chemical industry and desalination of sea water etc.

CNP has now entered into the fast track of development and has taken a major step forward in forging China Strong Pump Enterprise and World's famous brand in the Pump Industry. In order to better meet the client's needs and requirements for expansion, it has set up a wide network of selling and service, as well as offices and service centers in major cities in China, which are aimed at providing timely and effective services for our clients. Meanwhile, our company has successfully penetrated into the world market by forging a good business relationship with more than 50 countries and regions in the Europe, Northern American, and Southeast Asia etc.

Content

WQ, WQ-JY	3
Summary	3
Application	3
Working conditions	3
Model definition	3
Structure	4
Sectional drawing	5
Installation type	7
Technical data and dimensions	9
Performance curve	12
WQ-F	17
Summary	17
Application	17
Working conditions	17
Model definition	17
Sectional drawing	18
Performance curve	18
Technical data and dimensions	19
WQ-QG	20
Summary	20
Application	20
Working conditions	20
Structure	20
Model definition	20
Sectional drawing	20
Technical data and dimensions	21
Performance curve	21
Supply range	22
Ordering Instructions	22
NFK electric control cabinet	23

● WQ, WQ-JY Summary

- WQ, WQ-JY improve the same type pumps of the local and overseas. It optimizes the hydraulic, seal technology, structure, protection. And it innovates, makes it more reliable and safe. Easy to use, long service life, good drainage capacity. The whole series is easy for selection. If fit with electronic control cabinet, which will protect pump.
- Optimize performance, two channel impeller, two to three mechanical seal, make mechanical seal lubricate, and cool better, run stable without clogging, easy to pass for pumped liquid.
- Mechanical seal is tandem type, the shaft seal is more reliable, long service life.
- The improvement the structure is benefit for seal, running reliable, less vibration, optimized structure, pump is easy for usage.
- IPX8 motor, good cooling performance, temperature rise is lower than normal motor, endurable, Class F insulation to ensure the long service life of motor.
- There are many protections in the motor, easy for selection.

● Application

- Building, hospital, residential area, municipal projects, roads, factory sewage, small sewage treatment, etc. The pumped liquid can be rain water, waste water with solid, long fabrics

● Working conditions

- Power supply: 50Hz, 3PH, 380V
- Medium temperature < 40°C, PH value is 4-10, medium density < 1200kg/m³ solid and liquid ratio < 2%.
- The lowest liquid level shall in conform to the lowest liquid in the installation drawing.
- The pump is not suitable for strongly corrosion liquid or strongly corrosion solid.
- The solid shall not exceed the max. allowed solid diameter.

● Definition of model

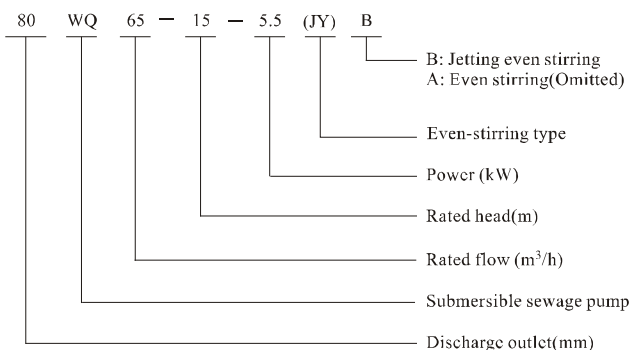

● Structure

- Carefully selection and matching of the pump body and impeller, the flow through with good performance, high efficiency, flat power curve, not easy to overload. Impeller is balance and precise with less vibration and stable rotation.
- Motor: Specially designed submersible motor, the protection level is IPX8, Insulation class: F, cooling performance is good, long insulation service life.
- Motor cooling: The motor heat is cooled by motor shell. As long as the medium is over half of the stator shell, it can run safely.
- Shaft seal: Two or three sets of mechanical seal work in series. One seal separate medium from the oil chamber. Other two seals separate oil from the motor.
- Oil chamber: There is suitable oil in the oil chamber, there are two mechanical seal, oil chamber is separate medium from the motor. If the first mechanical seal is leaked, there is oil in oil chamber to prevent liquid from going to the motor. And the two separate mechanical seals can be lubricated and cooled, it make mechanical seal work stably, and, it will take away some heat caused by bottom bearing and motor.
- Bearing: The bottom bearing sets forms the stably support for shaft. According to the radial force, axial force and the load, the bottom bearing can be formed with two or three kinds of different bearings, to ensure pump work stable and service long life.
- Cable and mechanical seal:
 - 1.The cable is soft rubber cable which can resist sewage. It is designed according to ambient temperature 40 degree centigrade and motor full load working conditions. When pump is working, keep motor working at not full load or ambient temperature below 40 degree, pumps can work longer.
 - 2.There is seal between cable rubber cover and motor, it can prevent medium leak to motor cabinet.
 - 3.Cable slot and cables are rubber vulcanization, if rubber cover is broken, it can prevent medium leak to motor cabinet also.
- Motor shell: Base, bearing seat, motor cover composed the motor shell. There are seals at the part joint. Every pump is water pressure tested to ensure the seal.
- Safe protection in pump(Earthed professional power supply controlled cabinet):
 - 1.Oil water detector, it is installed in the oil chamber, check the leakage of the first mechanical seal(in the medium), when the medium leaked to oil chamber to some amount, it will alarm.
 - 2.Water in detector: It is installed in the motor cabinet, detect the second mechanical seal leak, when oil or oil water mixture go into the motor, water in detector will alarm and stop pump.
 - 3.Thermal part: It is installed in the windings of motor stator, if motor overload for long time, the temperature of windings will increase(or other reason cause temperature rise) to some amount, it will alarm and stop pump.
- Outer control system: The user shall use the professional control cabinet to control and protect pump. When users use their own control cabinet, please contact us to instruct them to install protection controller.
- Special hand lift for easy movement. It is prohibited to pump/move pump by the cable, it will loose the seal between cable and motor cover which will cause leakage. Fix cable on the hand lift also prohibited to move pump with cable.
- Performance curve and main technical data: The performance curve show the recommended pump running scope. When the medium changed, please ensure the shaft power should be within the rated motor power range. When overload, motor will burn.

Sectional view

WQ($\leq 11\text{kW}$)

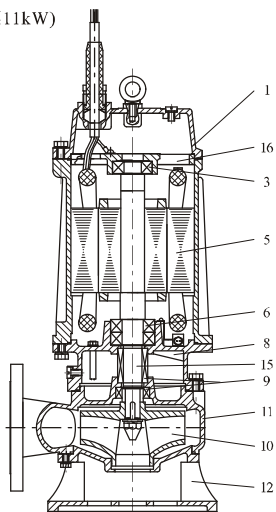

Material

No.	Name	Material
1	Pump cover	Cast iron HT200
3	Bearing	
5	Motor	
6	Bearing	
8	Oil chamber	Cast iron HT200
9	Mechanical seal	Sic/Tungsten Carbide
10	Impeller	Cast iron HT200
11	Casing	Cast iron HT200
12	Base	Cast iron HT200
15	Shaft	Stainless steel2Cr13
16	Thermal protector	

WQ($> 11\text{kW}$)

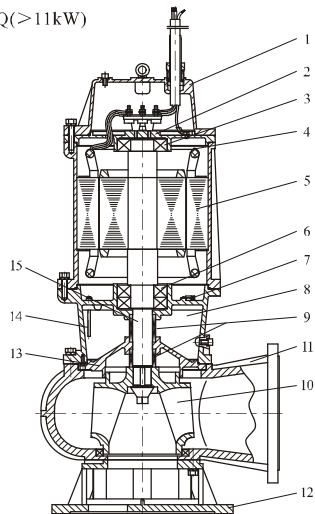

No.	Name	Material
1	Pump cover	Cast iron HT200
2	Upper bearing seat	Cast iron HT200
3	Bearing	
4	Heat control switch	
5	Motor	
6	Bearing	
7	Water in detector	
8	Oil chamber	Cast iron HT200
9	Mechanical seal	Sic/Tungsten Carbide
10	Impeller	Cast iron HT200
11	Casing	Cast iron HT200
12	Base	Cast iron HT200
13	Oil chamber cover	Stainless steel
14	Oil water detector	
15	Shaft	Stainless steel2Cr13

Sectional view

WQ-JY(A)

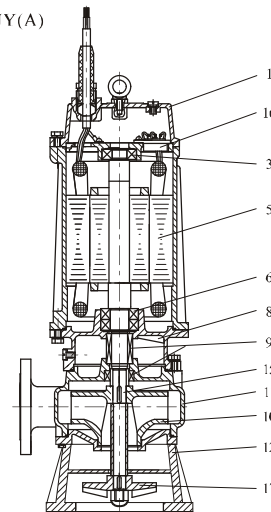

Material

No.	Name	Material
1	Pump cover	Cast iron HT200
3	Bearing	
5	Motor	
6	Bearing	
8	Oil chamber	Cast iron HT200
9	Mechanical seal	Sic/Tungsten Carbide
10	Impeller	Cast iron HT200
11	Casing	Cast iron HT200
12	Base	Cast iron HT200
15	Shaft	Stainless steel2Cr13
16	Thermal protector	
17	Stir impeller	Cast iron HT200

WQ-JY(B)

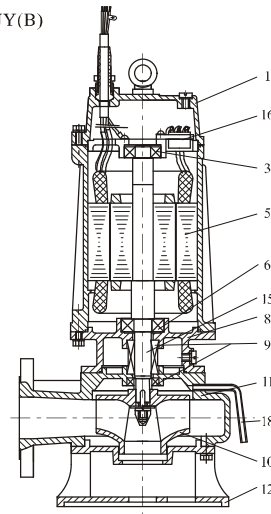

No.	Name	Material
1	Pump cover	Cast iron HT200
3	Bearing	
5	Motor	
6	Bearing	
8	Oil chamber	Cast iron HT200
9	Mechanical seal	Sic/Tungsten Carbide
10	Impeller	Cast iron HT200
11	Casing	Cast iron HT200
12	Base	Cast iron HT200
15	Shaft	Stainless steel2Cr13
16	Thermal protector	
18	Ejecting pipe	

● Installation type

For WQ, JYWQ pumps, there is auto coupling device installation (Z), hard pipe movable installation(Y), soft pipe movable installation(R)

Fixed auto coupling device installation

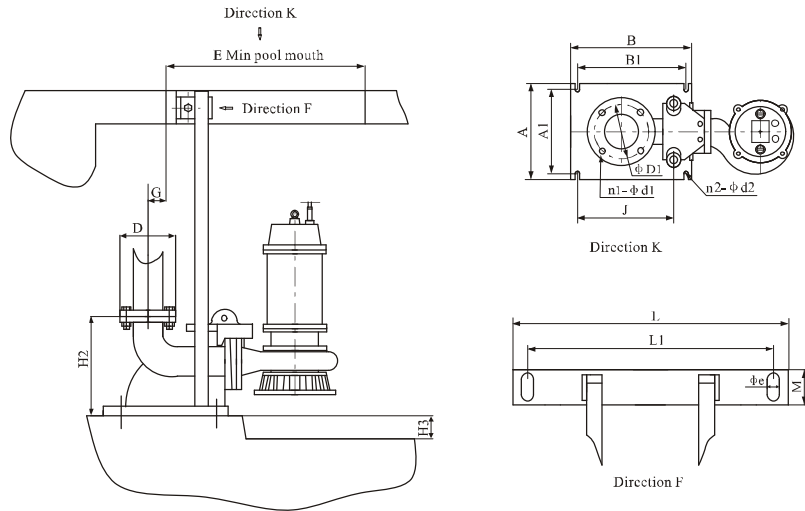

Movable installation

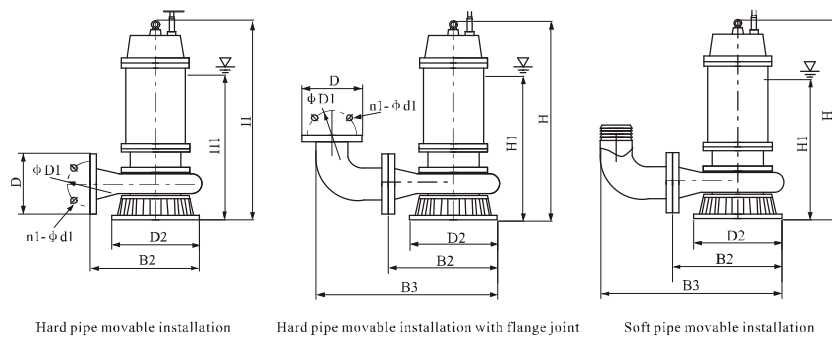

● Coupling device dimensions(Same for WQ-F,WQ-QG)

No.	Model	Flange connection size PN6 (mm)			Coupling base dimensions (mm)					G	H2	H3	L	L1	m	φe	E
		D	D1	n1-φd1	A	A1	B	B1	n2-φd2								
1	50WQ(JY)	140	110	4-φ14	197	168	285	206	4-φ16	90	250	160	265	220	50	13	550×550
2	65WQ(JY)	160	130	4-φ14	238	200	320	240	4-φ16	130	265	165	280	235	50	13	650×600
3	80WQ(JY)	190	150	4-φ18	278	238	354	260	4-φ18	165	285	165	315	260	50	13	650×600
4	100WQ(JY)	210	170	4-φ18	320	260	375	300	4-φ18	175	305	185	410	315	60	15	750×650
5	150WQ(JY)	265	225	8-φ18	400	300	410	350	4-φ18	190	480	200	410	260	60	15	1000×800
6	200WQ(JY)	320	280	8-φ18	400	300	450	350	4-φ18	230	550	200	410	260	60	15	1300×900
7	250WQ(JY)	375	335	12-φ18	460	360	560	430	4-φ24	230	630	200	410	260	60	15	1600×1300
8	300WQ(JY)	440	395	12-φ22	600	540	600	540	4-φ24	375	650	250	700	615	150	20	1600×1300
9	350(JY)WQ	490	445	12-φ22	600	540	600	540	4-φ24	390	700	250	700	615	150	24	1600×1300

● Dimensions

Measure: mm (except inch)

Item	Diameter	50	65	80	100	150	200	250	300	350	
Guide rod Tap pipe/ Steel pipe		1" /32×3.5		1.5" /48×3.5				2" /60×5			
Guide rod length		Pool depth - 30			Pool depth - 390	Pool depth - 440	Pool depth - 450	Pool depth - 480			
Quantity of expansion bolt and specification		2-M12×150			3-M12×150			3-M16×150			
Quantity of bolt and specification		4-M16×250				4-M20×300					
footer bolt hole size		80×80×300				100×100×350					
Dia. of rubber pipe		2" /50	2.5" /65	3" /76	4" /100	6" /150	8" /200	10" /250	12" /300	14" /350	

● Technical data and dimensions

Model	Q (m ³ /h)	H (m)	Speed (rpm)	Power (kW)	Current (A)	Max. dia. of passing solid (mm)	Dimensions(mm)											Weight (kg)
							H	H*	H1	H1*	B3	B2	D2	d	D	D1	n1-φ d1	
200WQ300-9-18.5(JY)	300	9	1450	18.5	37.0	50	1020	800	890	610	420	200	320	280	8-φ 18	285		
200WQ400-10-22(JY)	400	10	1450	22	45.0	50	1070	850	890	610	420	200	320	280	8-φ 18	315		
200WQ300-15-22(JY)	300	15	1450	22	45.0	50	1070	850	890	610	420	200	320	280	8-φ 18	315		
200WQ250-22-30(JY)	250	22	1450	30	60.0	50	1240	980	900	620	470	200	320	280	8-φ 18	450		
200WQ360-15-30(JY)	360	15	1450	30	60.0	50	1240	980	900	620	470	200	320	280	8-φ 18	450		
200WQ400-13-30(JY)	400	13	1450	30	60.0	50	1240	980	900	620	470	200	320	280	8-φ 18	450		
200WQ300-20-37(JY)	300	20	1450	37	75.0	50	1240	980	900	620	470	200	320	280	8-φ 18	650		
200WQ350-25-37(JY)	350	25	1450	37	75.0	50	1240	980	900	620	470	200	320	280	8-φ 18	650		
200WQ400-18-37(JY)	400	18	1450	37	75.0	50	1240	980	900	620	470	200	320	280	8-φ 18	650		
200WQ250-35-45(JY)	250	35	1450	45	90.0	45	1290	1030	900	620	470	200	320	280	8-φ 18	850		
200WQ400-25-45(JY)	400	25	1450	45	90.0	50	1290	1030	900	620	470	200	320	280	8-φ 18	850		
200WQ250-40-55(JY)	250	40	1450	55	110.0	45	1450	1050	1050	770	560	200	320	280	8-φ 18	1000		
200WQ400-30-55(JY)	400	30	1450	55	110.0	45	1450	1050	1050	770	560	200	320	280	8-φ 18	1000		
200WQ350-40-75(JY)	350	40	1450	75	150.0	45	1520	1120	1050	770	560	200	320	280	8-φ 18	1200		
250WQ600-9-30(JY)	600	9	1450	30	60.0	55	1300	1050	980	640	470	250	375	335	12-φ 18	450		
250WQ600-12-37(JY)	600	12	1450	37	75.0	55	1300	1050	980	640	470	250	375	335	12-φ 18	650		
250WQ800-12-45(JY)	800	12	1450	45	90.0	60	1350	1100	980	640	470	250	375	335	12-φ 18	850		
250WQ600-15-45(JY)	600	15	1450	45	90.0	55	1350	1100	980	640	470	250	375	335	12-φ 18	850		
250WQ600-20-55(JY)	600	20	1450	55	110.0	55	1450	1050	1210	870	560	250	375	335	12-φ 18	1000		
250WQ600-25-75(JY)	600	25	1450	75	150.0	55	1520	1120	1210	870	560	250	375	335	12-φ 18	1200		
250WQ600-30-90(JY)	600	30	1450	90	180.0	55	1570	1170	1210	870	560	250	375	335	12-φ 18	1300		
300WQ800-8-37(JY)	800	8	1450	37	75.0	60	1400	1150	1200	800	470	300	440	395	12-φ 22	650		
300WQ500-15-45(JY)	500	15	1450	45	90.0	55	1450	1200	1200	800	470	300	440	395	12-φ 22	850		
300WQ800-12-45(JY)	800	12	1450	45	90.0	60	1450	1200	1200	800	470	300	440	395	12-φ 22	850		
300WQ600-20-55(JY)	600	20	1450	55	110.0	55	1480	1080	1270	870	560	300	440	395	12-φ 22	1000		
300WQ800-20-75(JY)	800	20	1450	75	150.0	60	1520	1120	1270	870	560	300	440	395	12-φ 22	1200		
300WQ950-20-90(JY)	950	20	1450	90	150.0	65	1570	1170	1270	870	560	300	440	395	12-φ 22	1300		
300WQ1000-25-110(JY)	1000	25	1450	110	220.0	70	2200	2100	1900	1500	600	300	440	395	12-φ 22	1400		
350WQ1500-7-45(JY)	1500	7	1450	45	90.0	80	2100	2100	1880	1380	500	350	490	445	12-φ 22	860		
350WQ1100-10-55(JY)	1100	10	1450	55	110.0	75	2150	2100	1880	1380	560	350	490	445	12-φ 22	1000		
350WQ1200-13-75(JY)	1200	13	1450	75	150.0	75	2150	2100	1900	1400	560	350	490	445	12-φ 22	1200		
350WQ1300-10-75(JY)	1300	10	1450	75	150.0	75	2150	2100	1900	1400	560	350	490	445	12-φ 22	1200		
350WQ1200-15-90(JY)	1200	15	1450	90	180.0	75	2190	2150	1950	1450	560	350	490	445	12-φ 22	1350		
350WQ1130-18-90(JY)	1130	18	1450	90	180.0	75	2190	2150	1950	1450	560	350	490	445	12-φ 22	1350		

Remark: H*, H1* is the size of JYWQ

● Performance curve

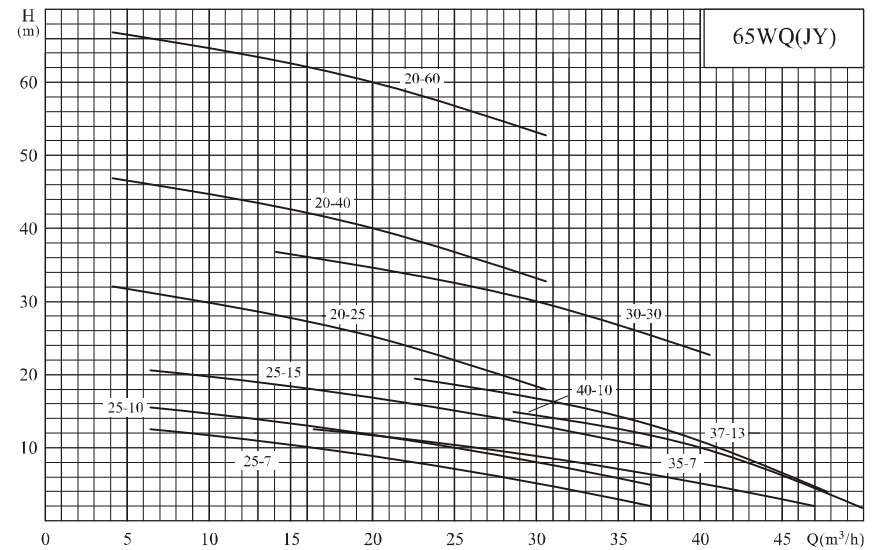
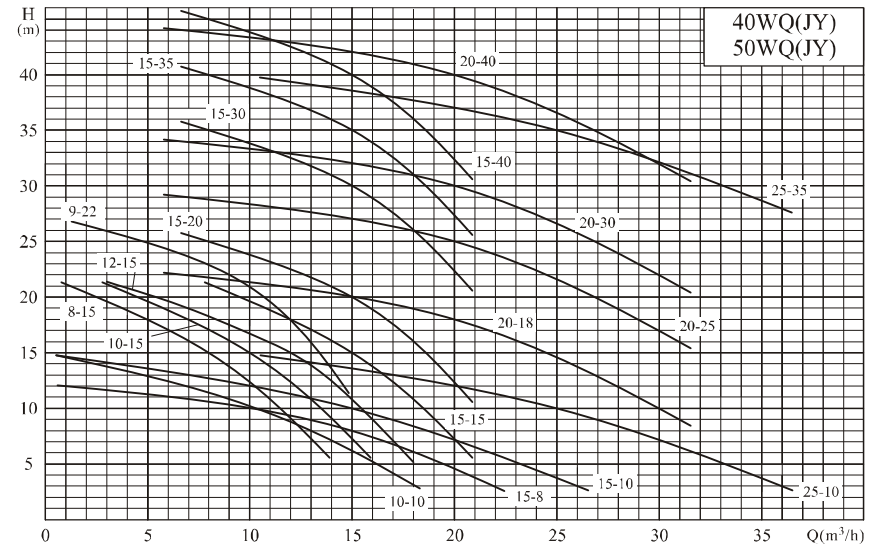

● Performance curve

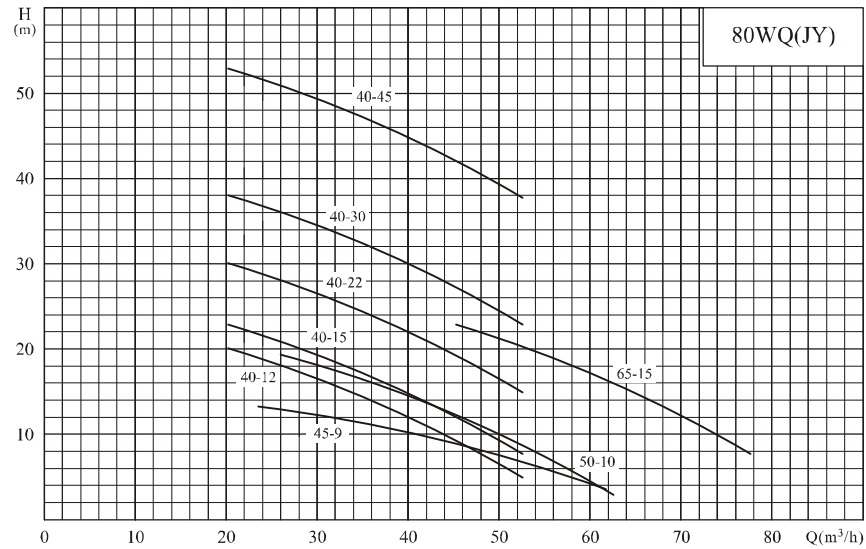

● Performance curve

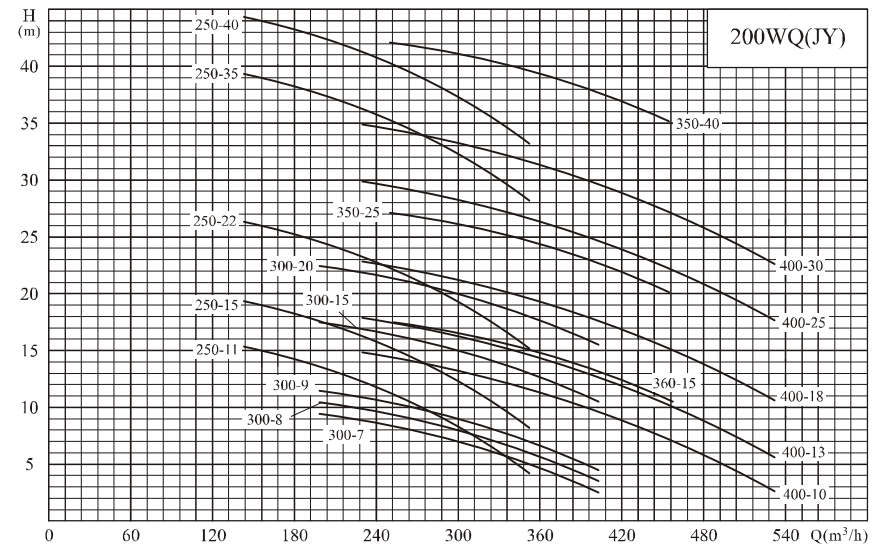
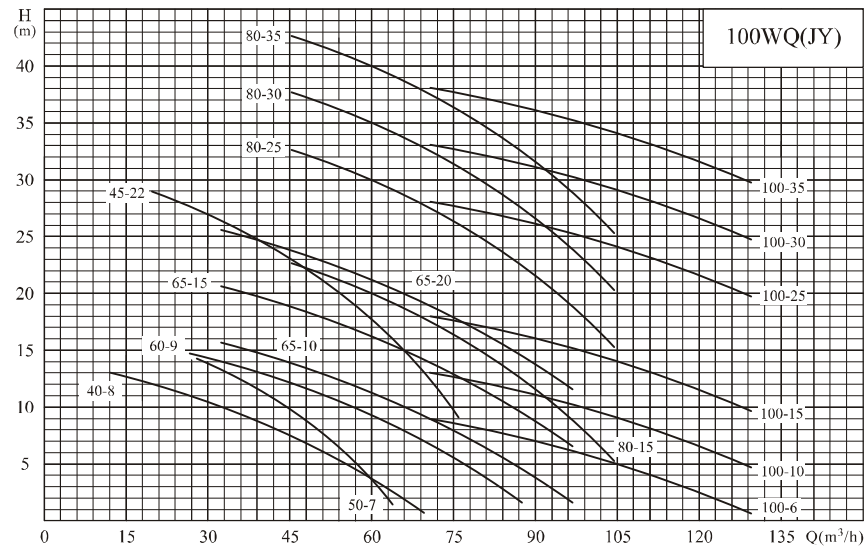
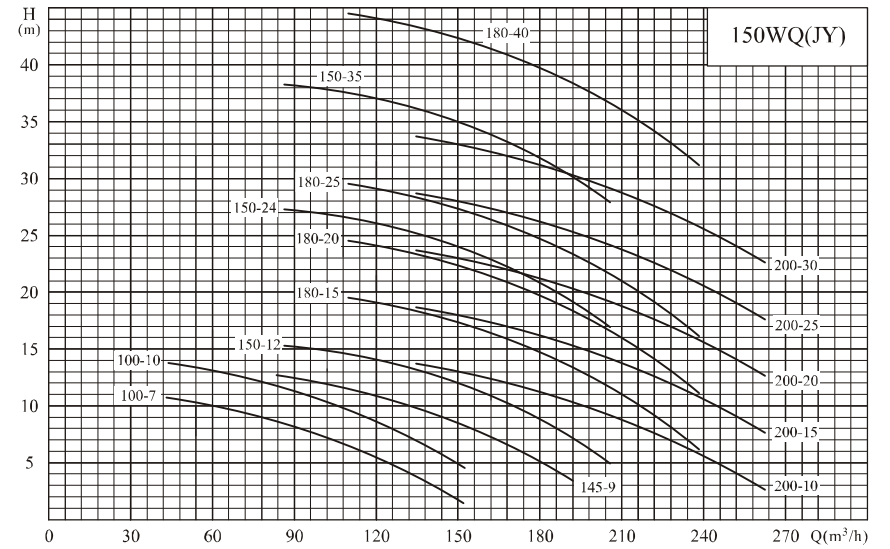

● Performance curve

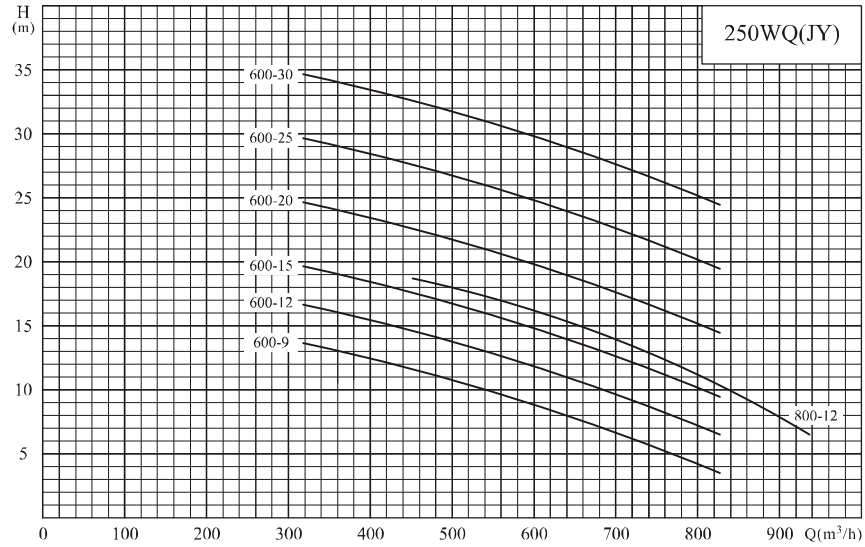

● Performance curve

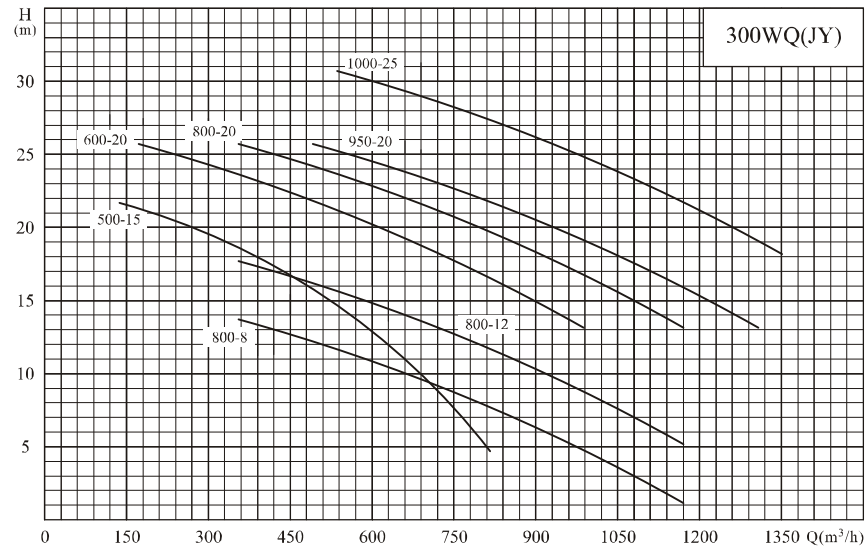
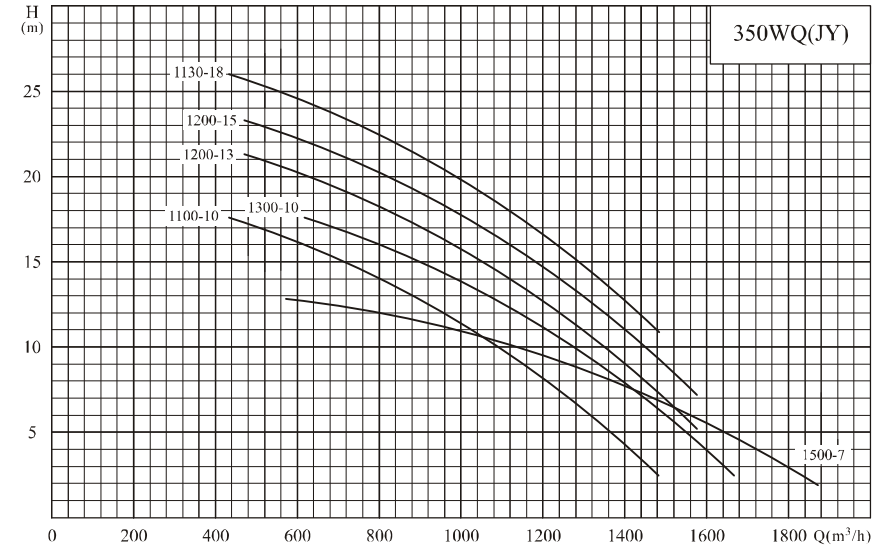

WQ-F Summary

● WQ-F full stainless steel sewage submersible pump improve the same type pumps of the local and overseas. It is specially for miners, buildings, municipal projects, sewage treatment applications.

● Wet parts of pump are made of casting stainless steel. It is self non polluted and anti corrosive, it expands the drainage applications area.

● High efficient, good structure, non-clogging, anti-twisting, small space, light weight, running safe and reliable, long service time.

● The on request two guides auto coupling device system, it is convenient for pump installation.

● Two faces mechanical seal, use tungsten carbide, it can works more than 10000 hours.

● There is auto coupling device installation (Z), hard pipe movable installation (Y), soft pipe movable installation (R)

Application

● Projects, industrial enterprises, municipal projects, etc. sewage water treatment system.

● Sewage transportation in the municipal sewage system.

● Prospection, mines, etc.

● Sewage water drainage for food, hospital, sea water, ship.

● Irrigation, fen, aquaculture, sprinkle, etc.

Working conditions

● Power supply: 50Hz, 3 × 380V

● Medium temperature < 60°C, PH value is 2-12, medium density < 1200kg/m³, solid and liquid ratio < 2%.

● When working, motor on liquid level shall more than 1/2 of the whole motor.

Model definition

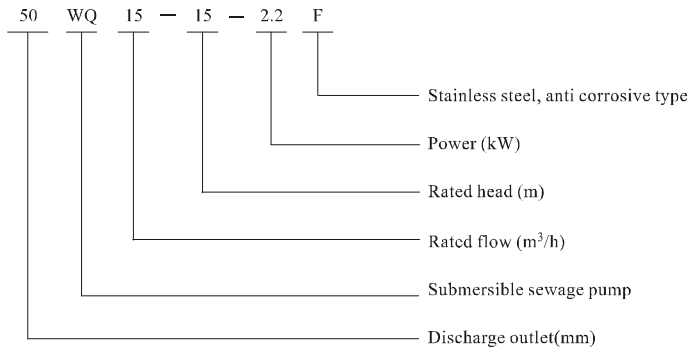

Sectional drawing

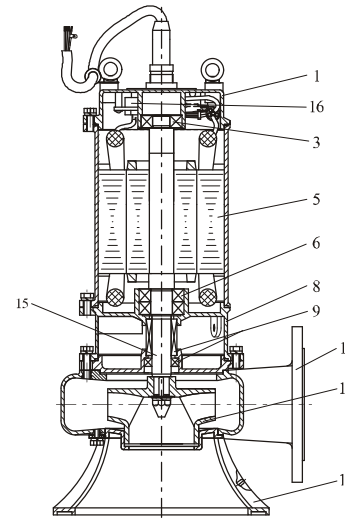

Material

No.	Name	Material
1	Pump cover	Stainless steel0Cr18Ni9
3	Bearing	
5	Motor	
6	Bearing	
8	Oil chamber	Stainless steel0Cr18Ni9
9	Mechanical seal	Sic/Tungsten Carbide
10	Impeller	Stainless steel0Cr18Ni9
11	Casing	Stainless steel0Cr18Ni9
12	Base	Stainless steel0Cr18Ni9
15	Shaft	Stainless steel2Cr13
16	Thermal protector	

Performance curve

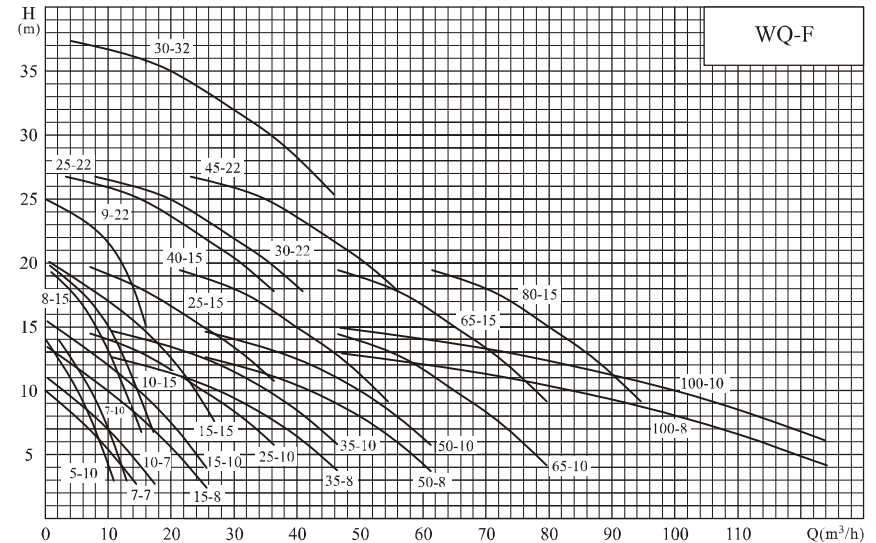

● **Technical data and dimensions(Installation drawing is same as WQ)**

Model	Q	H	Speed	Power	Current	Max. dia. of passing solid (mm)	Dimensions(mm)								Weight (kg)	
	(m ³ /h)	(m)	(rpm)	(kW)	(A)		H	H1	B3	B2	D2	d	D	D1		n1-φd1
50WQ7-7-0.55F	7	7	2860	0.55	1.6	15	430	300	330	230	190	50	140	110	4-φ14	18
50WQ5-10-0.55F	5	10	2860	0.55	1.6	15	430	300	330	230	190	50	140	110	4-φ14	18
50WQ10-7-0.75F	10	7	2860	0.75	2.0	20	430	300	330	230	190	50	140	110	4-φ14	18
50WQ7-10-0.75F	7	10	2860	0.75	2.0	20	430	310	330	230	190	50	140	110	4-φ14	18
50WQ15-8-1.1F	15	8	2860	1.1	2.8	20	430	310	330	230	190	50	140	110	4-φ14	20
50WQ8-15-1.1F	8	15	2860	1.1	2.8	20	430	310	330	230	190	50	140	110	4-φ14	20
50WQ15-10-1.5F	15	10	2860	1.5	4.0	20	485	330	350	250	200	50	140	110	4-φ14	28
50WQ10-15-1.5F	10	15	2860	1.5	4.0	20	485	330	350	250	200	50	140	110	4-φ14	28
50WQ25-10-2.2F	25	10	2860	2.2	6.0	25	485	345	350	250	200	50	140	110	4-φ14	30
50WQ15-15-2.2F	15	15	2860	2.2	6.0	20	485	345	350	250	200	50	140	110	4-φ14	30
50WQ9-22-2.2F	9	22	2860	2.2	6.0	20	485	345	350	250	200	50	140	110	4-φ14	30
50WQ25-15-3F	25	15	2860	3	6.5	20	510	400	370	270	200	50	140	110	4-φ14	37
50WQ25-22-4F	25	22	2860	4	8.4	25	600	440	380	280	250	50	140	110	4-φ14	48
50WQ30-32-7.5F	30	32	2860	7.5	16.8	25	640	500	440	346	320	50	160	130	4-φ14	63
65WQ35-8-2.2F	35	8	2860	2.2	6.0	25	485	345	380	250	200	65	160	130	4-φ14	30
65WQ35-10-3F	35	10	2860	3	6.5	25	520	420	400	270	200	65	160	130	4-φ14	37
65WQ40-15-4F	40	15	2860	4	8.4	30	610	440	410	280	250	65	160	130	4-φ14	48
65WQ30-22-5.5F	30	22	2860	5.5	12.0	25	630	470	420	290	250	65	160	130	4-φ14	55
80WQ50-8-3F	50	8	2860	3	6.5	30	520	420	400	270	200	76	190	150	4-φ18	37
80WQ50-10-4F	50	10	2860	4	8.4	30	610	440	410	280	250	76	190	150	4-φ18	48
80WQ65-15-5.5F	65	15	2860	5.5	12.0	30	630	470	420	290	250	76	190	150	4-φ18	55
80WQ45-22-7.5F	45	22	2860	7.5	16.8	30	650	490	440	310	290	76	190	150	4-φ18	68
100WQ65-10-4F	65	10	2860	4	8.4	30	610	440	440	280	250	100	210	170	4-φ18	48
100WQ100-8-5.5F	100	8	2860	5.5	12.0	35	640	480	420	290	250	100	210	170	4-φ18	58
100WQ80-15-7.5F	80	15	2860	7.5	16.8	30	660	500	460	310	290	100	210	170	4-φ18	73
100WQ100-10-7.5F	100	10	2860	7.5	16.8	35	660	500	460	310	290	100	210	170	4-φ18	73

● **WQ-QG Summary**

- With the design of special chopper plate, WQ cutting type submersible sewage pump can crush foreign matters.
- There are three ways of installation: auto device installation, hard pipe movable installation, soft pipe movable installation. (same as WQ series)

● **Application**

- Sewage with foreign matter, domestic sewage and industrial sewage drainage.

● **Working Conditions**

- Power: 50Hz, 3X380V
- Medium temperature is less than 40°C; PH value is between 4 and 10; Density shall less than 1200kg/m³; Solid and liquid ratio shall less than 2%.
- When working, motor on liquid level shall not more than 1/2 of the whole motor.

● **Structure Specification**

The impeller is single channel non-block cutting impeller, the chopper plate placed between base and casing can regulate the axial clearance between cutting impeller. The shear effect of cutting wheel and chopper plate can chop and discharge any inhaled long fiber solids.

● **Model definition**

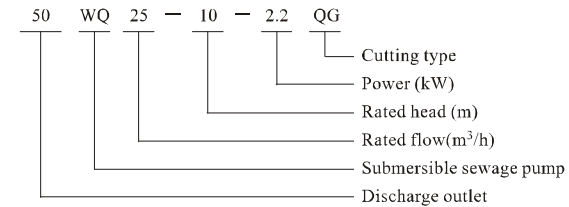

● **Sectional drawing**

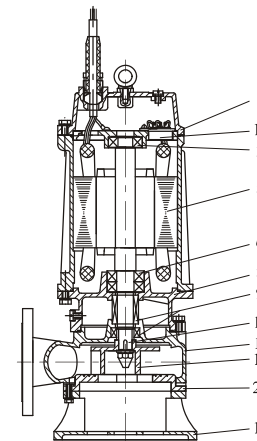

● **Material**

No.	Name	Material
1	Pump cover	Cast Iron HT200
3	Bearing	
5	Motor	
6	Bearing	
8	Oil chamber	Cast Iron HT200
9	Mechanical seal	Sic/Tungsten Carbide
10	Impeller	Cast Iron HT200
11	Casing	Cast Iron IIT200
12	Base	Cast Iron HT200
15	Shaft	Stainless steel 2Cr13
16	Thermal protector	
22	Chopper plate	Steel

● Technical data and dimension (installation diagram as same as WQ)

Model	Q	H	Speed	Power	Current	Dimensions(mm)										Weight (kg)
	(m ³ /h)	(m)	(rpm)	(kW)	(A)	H	H1	B3	B2	D2	d	D	D1	n1-φd1		
50WQ10-7-0.75QG	10	7	2860	0.75	2.0	450	340	300	210	190	50	140	110	4-φ14	20	
50WQ15-9-1.1QG	15	9	2860	1.1	2.8	480	370	300	210	190	50	140	110	4-φ14	23	
50WQ25-7-1.5QG	25	7	2860	1.5	4.0	520	410	360	270	200	50	140	110	4-φ14	28	
50WQ25-10-2.2QG	25	10	2860	2.2	6.0	550	440	360	270	200	50	140	110	4-φ14	30	
80WQ42-12-3QG	42	12	2860	3	6.5	600	490	420	300	250	76	190	150	4-φ18	57	
80WQ50-10-4QG	50	10	2860	4	8.4	630	520	420	300	250	76	190	150	4-φ18	60	
100WQ65-12-5.5QG	65	12	2860	5.5	12.0	700	560	500	340	260	100	210	170	4-φ18	85	
100WQ85-12-7.5QG	85	12	2860	7.5	16.8	740	600	500	340	260	100	210	170	4-φ18	94	

● Performance curve

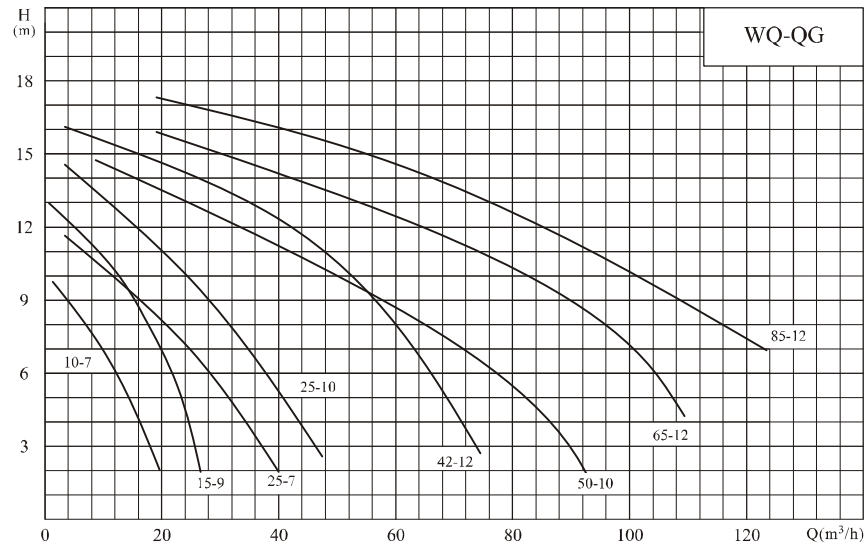

● Supply range

Installation type	With the accessory	Optional part		Spares
Soft pipe movable installation	Pump, rubber joint	Hose	Control cabinet, end cabinet, butterfly valve non return valve, chains (for sinking pump)	Impeller, seal ring, bearing, mechanical seal
Hard pipe movable installation	Pump, flange	Dual flange joint		
Auto coupling device installation	Pump, auto coupling device	Guide rod, footer bolt, expanding bolt		

● Ordering Instructions

1. Please note product model, name, performance data (flow, head), installation way, optional part, spare part etc. Please take into consideration the impact of medium density on power and the requirements of overcurrent sealing elements (corrosivity of medium, wear resistance).
2. If there is special requirement for the protection in the pump (oil detector, water detector, thermal element), please note when ordering. The control mode and automation requirement should be noted when ordering electric control cabinet.
3. The standard cable length for the submersible sewage pump is 10m. If needs prolong, please specify.
4. Please specify whether need the dual cable (normally for motor power bigger than 7.5kW).

Product features

● It has the protection function of overload, short circuit, phase break protection, motor overheating and electric leakage. With the working mode of single pump control and multiple pump control, switching mode of main pump and standby pump, and various starting mode, it can apply to automatic control of water supply and drainage of agricultural production and buildings.

Function

● Main pump and standby pump can arbitrary select and combine from one control one to one control six; various starting mode and control type; fault switching; able to customize it as you like; electric control cabinet with more than 4 pumps use PLC intelligent control elements.

Model Definition

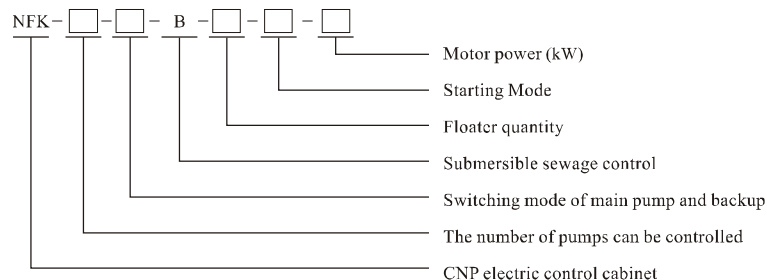

Description of Model and Function

Quantity of controlled pump

"1" stands for one control one; "2" stands for one control two; "3" stands for one control three; "4" stands for one control four.

"I" stands for a pump with a backup; "II" stands for two pump with a backup; "III" stands for three pump with a backup; "IV" stands for four pump with a backup.

One control two: control pump 1# and pump 2#. The two pumps run simultaneously, pump 2# will run automatically by time relay after pump 1# is started.

One control three: control pump 1#, pump 2# and pump 3#. working mode is same as above.

A pump with a backup: control pump 1# and pump 2#. There are two operation mode: ① pump 1# as main pump and pump 2# as backup; ② pump 2# as main pump and pump 1# as backup.

Two pump with a backup: control pump 1#, pump 2# and pump 3#. There are three operation mode: ① pump 1#, pump 2# as main pump and pump 3# as backup; ② pump 2#, pump 3# as main pump and pump 1# as backup; ③ pump 1#, pump 3# as main pump and pump 2# as backup.

Three pump with a backup: control pump 1#, pump 2#, pump 3# and pump 4#. There are four operation mode: ① pump 1#, pump 2#, pump 3# as main pump and pump 4# as backup; ② pump 2#, pump 3#, pump 4# as main pump and pump 1# as backup; ③ pump 1#, pump 3#, pump 4# as main pump and pump 2# as backup; ④ pump 1#, pump 2#, pump 4# as main pump and pump 3# as backup;

The above operation and working mode all have manual function. Each pump can work under manual condition.

Switching mode of main pump and backup.

"H" stands for ordinary type. User can select main pump and backup manually before starting the machine.

When the main pump breakdown, the reserved pump will start automatically. It is commonly used.

"AS" stands for timing automatic switchover/manual switch. It can be used for timing alternation of main pump and reserved pump. Regular switching time: 8-12 hours. User can switch from timing automatic switch over to manual switch to select main pump and reserved pump. This type has the function of reserved pump automatic switching.

"AC" stands for automatic switch over/manual switch. Main pump and reserved pump will alternate each time the machine starts. User can switch from automatic switch over to manual switch to select main pump and reserved pump. This type has the function of reserved pump automatic switching.

Control Type

"B" stands for only for submersible sewage pump. Except to overload protection, short circuit protection and lack of phase protection, large pump has the function of pump body leakage protection and motor overheating protection.

Starting Mode

If not indicate, it refers to direct starting (usually the motor power is under 15 KW); "JY(Z)" stands for compensator starting (usually the motor power is above 15 kW); "R" stands for soft starting.

Soft starting can further reduce the impact to power and motor and extend service life of machine, eliminate water hammer effect and noise. It is energy-saving.

Motor Power

Number stands for the motor power of each controlled pump.

Model Definition Example

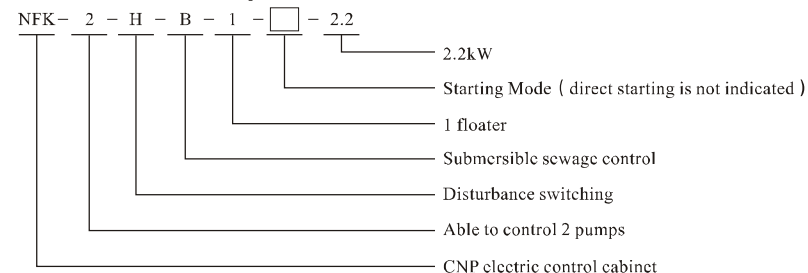

Dimension of electric control cabinet

1B type: 400(H)×300(L)×160(W)(mm)

2B type: 500(H)×360(L)×160(W)(mm)

Other model's specification depend on the quantity and power of controlled pumps.

